



STAINLESS STEEL PEGBOARDS

INTER DYNE SYSTEMS MOD-RACK™ PEGBOARDS

At Inter Dyne Systems we believe that an organized workstation functions better and helps you to operate more efficiently. That's why we've developed a full line of versatile workstation solutions, including our Mod-Rack™ pegboards. Mod-Rack pegboards serve a dual purpose in a modern laboratory. First, they allow you to quickly dry important, and often fragile, equipment in a sanitary manner. Second, our well-crafted pegboards are a safe place to store often used materials so they are readily at-hand when you need them. Mod-Rack pegboards come in a wide variety of sizes and mounting options and our selection of accessories allow you to completely customize your workstation. Custom sizes are available at a not so custom price and are furnished in a timely manner.



**INTER DYNE SYSTEMS:
VERSATILE WORK STATION SOLUTIONS**

Inter Dyne Systems began over 25 years ago as an innovator of modular laboratory equipment by fabricating and selling stainless steel pegboards.

Over time we gained a reputation as the leader in the laboratory pegboard market. We've built upon that foundation by continuing to offer high quality pegboards with dependable service, consistent quality and on time delivery. We also offer shelving components, narcotics storage cabinets, countertops and innovative acrylic products.

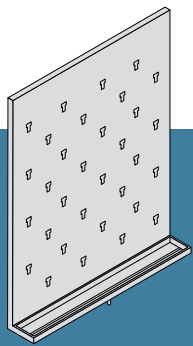

**"V" VICTORIA
STYLE**

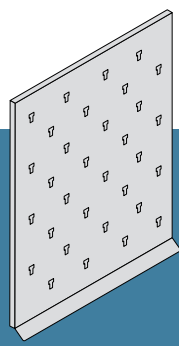

**"B" BARON
STYLE**

**MOD-RACK™ PEGBOARDS:
VICTORIA AND BARON STYLE**

The Victoria or "V" pegboard is constructed of lightweight stainless steel, offered in a range of sizes and variety of mounting options. Along the bottom is a drip trough that funnels water away to a drain, allowing equipment to dry quickly and remain sanitized. Each "V" style pegboard includes an integral drip trough, wall bracket, standard 6" white pegs and 3 ft. of clear plastic drain hose.

The "B" Baron is also made of lightweight stainless steel. It is offered in three sizes and a variety of mounting options. A drip deflector at the bottom diverts water away from walls and directs it to a sink or drain. Each "B" style pegboard includes a wall bracket and standard 6" white pegs.

"V" VICTORIA STYLE PEGBOARDS



MODEL NO.	SIZE WxH	NO. OF PEGS	SHIPPING WT.
-----------	----------	-------------	--------------

V1824	18" x 24"	15	13 lbs.
V2418	24" x 18"	16	13 lbs.
V2424	24" x 24"	20	16 lbs.
V2430	24" x 30"	32	23 lbs.
V2436	24" x 36"	40	25 lbs.
V3024	30" x 24"	25	23 lbs.
V3030	30" x 30"	50	24 lbs.
V3036	30" x 36"	40	23 lbs.
V3624	36" x 24"	30	25 lbs.
V3630	36" x 30"	60	23 lbs.
V3636	36" x 36"	66	25 lbs.
V4824	48" x 24"	40	24 lbs.
V4830	48" x 30"	48	28 lbs.
V4836	48" x 36"	88	31 lbs.

"B" BARON STYLE PEGBOARDS



MODEL NO.	SIZE WxH	NO. OF PEGS	SHIPPING WT.
-----------	----------	-------------	--------------

B2430	24" x 30"	32	14 lbs.
B3030	30" x 30"	50	17 lbs.
B3630	36" x 30"	50	21 lbs.



PEGBOARDS CAN BE WORKSTATIONS

The addition of our accessories such as drain shelves, cylinder yolks and drain baskets can change a simple pegboard into a customized and efficient workstation. We offer a variety of accessories and peg options, so no matter where you are working or what you are working with, you can get what you need right away.

ACCESSORIES

All of our accessories are made of the same high quality stainless steel as our pegboards. They come with a 5 year guarantee, can be sterilized by an autoclave and will easily help transform your Mod-Rack™ pegboard into your own customized workstation.

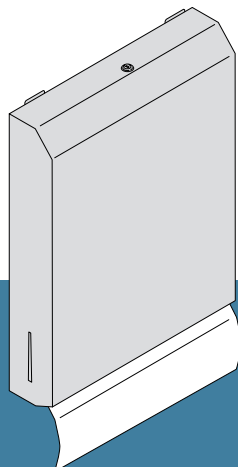

0210 Paper Towel
Holds up to 400 c-fold or 535 multi fold paper towels, 11" x 14.5" x 4".

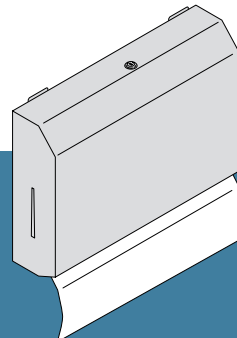

0215 Paper Towel
Holds up to 150 c-fold or multi fold paper towels, 11" x 8" x 4".

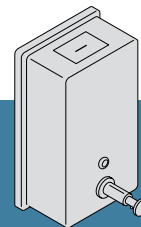

0343 Soap Dispenser
Holds up to 40 fl. oz. of liquid 4.75" x 8.5" x 3" Comes with pegboard & wall mount clips.

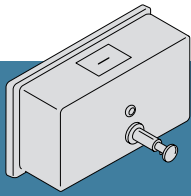

0342 Soap Dispenser
Holds up to 40 fl. oz. of liquid, 8.5" x 4.75" x 3". Comes with pegboard & wall mount clips.

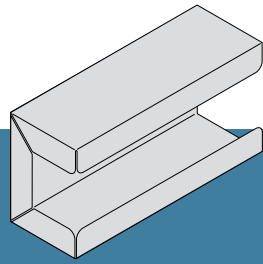

GD-10 Glove Dispenser
Holds most standard glove boxes.

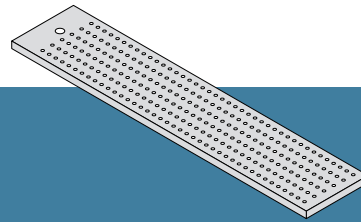

DG-2 & DG-4 Drain Grid
To accommodate smaller tools and equipment. 2" or 4" wide drain grid for drip trough.

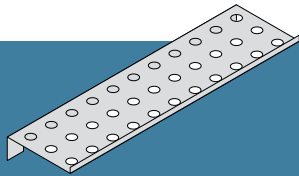

DS-12 Drain Shelf
12" shelf for drying small tools, cylinders and equipment. Shipped with required support pegs for installation.

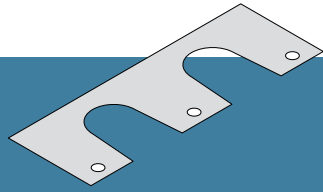

CY-12 Cylinder Yolk
12" yolk holds large cylinders or flasks. Shipped with required support pegs for installation.

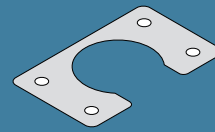

FH-6 Flask Holder
6" holder for drying Erlenmeyer flasks or large cylinders. Shipped with required support pegs for installation.

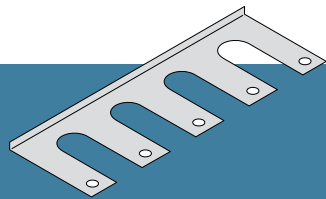

FR-12 Funnel Rack
12" rack holds up to four cylinders. Shipped with required support pegs for installation.

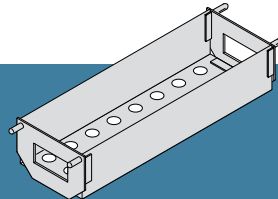

DB-12 Drain Basket
12" basket for drying smaller tools, cylinders and equipment. Shipped with required support pegs for installation.

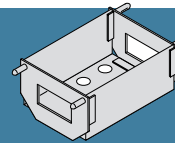

DB-6 Drain Basket
6" basket for drying smaller tools, cylinders and equipment. Shipped with required support pegs for installation.

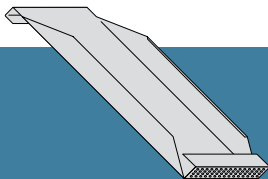

PR-12 Pipette Rack
12" shelf for drying glass or bulbous pipettes. Shipped with required support pegs for installation.

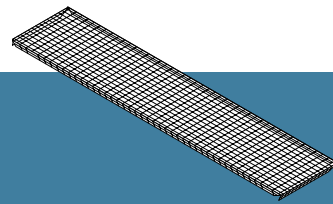

SI-4 Screen Insert
4" wide screen insert for drip troughs.

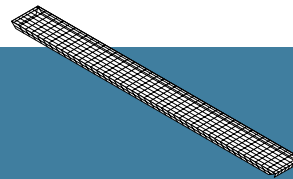

SI-2 Screen Insert
2" wide screen insert for drip troughs.

PEG OPTIONS

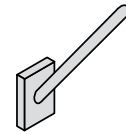

TP-4 Tube Peg
Perfect for smaller beakers, cylinders and funnels, 4"L, .25" dia.

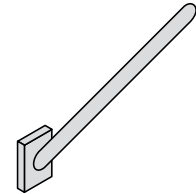

BP-6 Tube Peg
Perfect for smaller beakers, cylinders and funnels, 6"L, .5" dia.

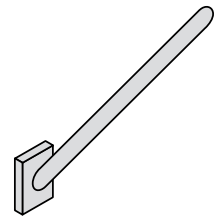

LP-9 Medium Peg
For small to medium beakers, cylinders and funnels, 9"L, .5" dia.

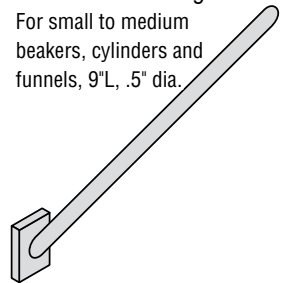

LP-12 Long Peg
Can accommodate medium to large beakers, cylinders and funnels, 12"L, .5" dia.

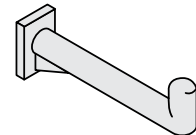

SP-4 Support Peg
Used for mounting racks, shelves and baskets, 4"L.

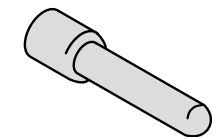

PE-3 Peg Extender
Lengthen all pegs an additional 3 inches.



HP-1 Peg Hole Cover
Seals unused peg holes.



ACCESSORY PACKAGES

To easily help customize your Mod-Rack™ pegboard, we've created functional package options that include some of our most popular accessories.



0210 Paper Towel Dispenser



0215 Paper Towel Dispenser



0343 Soap Dispenser



0342 Soap Dispenser



GD-10 Glove Dispenser



DB-12 Drain Basket



DB-6 Drain Basket



DG-2 or DG-4
Drain Grid



DS-12 Drain Shelf



FH-6 Flask Holder



FR-12 Funnel Rack



CY-12 Cylinder Holder



PR-12 Pipette Rack



SI-4 Screen Insert



SI-2 Screen Insert

MODEL NO.	SIZE WxH	NUMBER PEGS	COMPLETE WITH					
V1824/PKG	18"x24"	15						
V2418/PKG	24"x18"	16						
V2424/PKG	24"x24"	20						
V2430/PKG	24"x30"	32						
V2436/PKG	24"x36"	40						
V3024/PKG	30"x24"	25						
V3030/PKG	30"x30"	50						
V3036/PKG	30"x36"	40						
V3624/PKG	36"x24"	30						
V3630/PKG	36"x30"	60						
V3636/PKG	36"x36"	66						
V4824/PKG	48"x24"	40						
V4830/PKG	48"x30"	48						Multiple Sized Pegs
V4836/PKG	48"x36"	88						Multiple Sized Pegs

PEGBOARDS ARE ONLY THE BEGINNING

At Inter Dyne, pegboards and accessories are only the beginning of the quality laboratory equipment we offer. We also offer a wide variety of stainless steel shelving components, narcotics storage cabinets and countertops; as well as acrylic and epoxy pegboards.

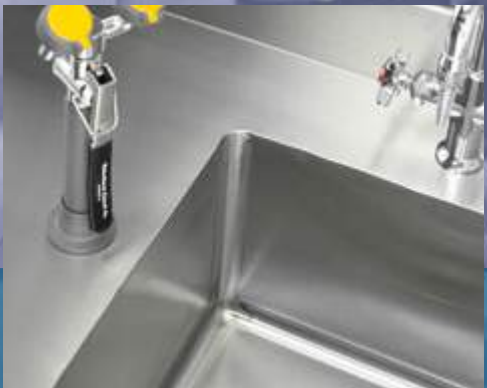
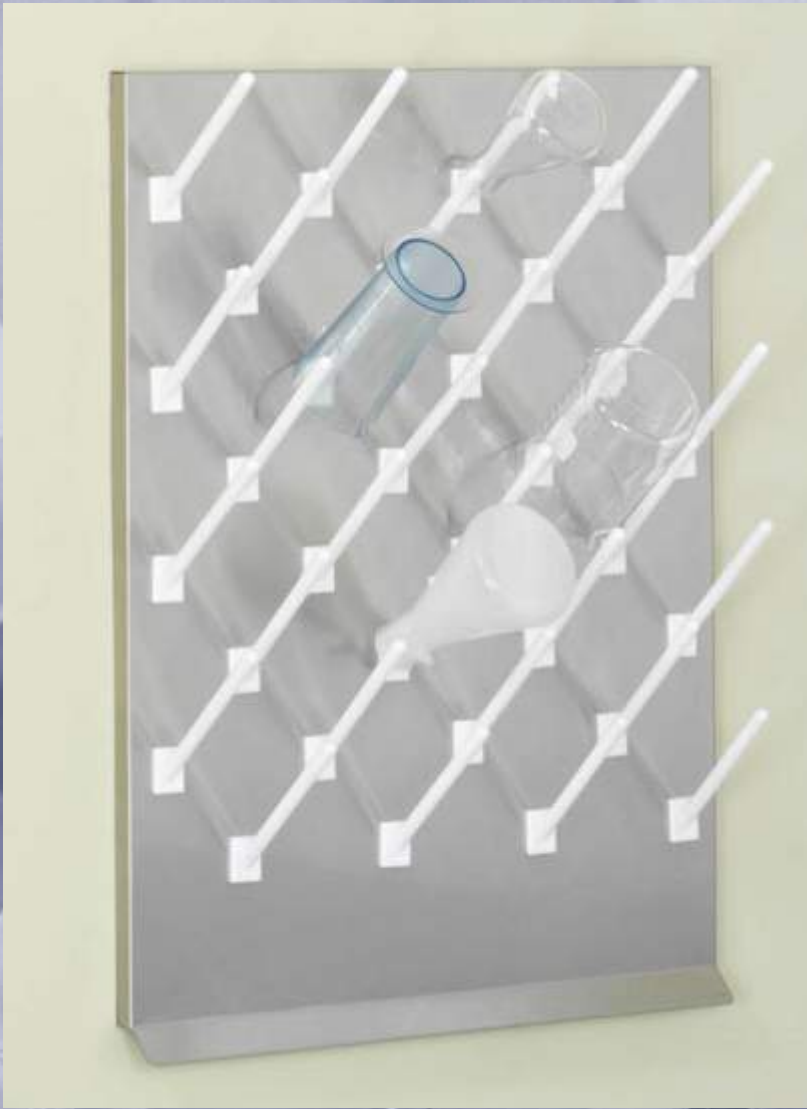

Our stainless steel countertops can be ordered to size with or without back/side splashes and integral sinks.

We have narcotics cabinets and specimen pass-through boxes in a variety of size, locking and mounting options.

Convenient and safe storage is a necessity in any lab. Our shelves and shelving components put everything you need right at your finger tips.

PEGBOARD MOUNTING OPTIONS



Wall Mount

All Mod-Rack Pegboards are shipped complete with our standard wall bracket that is clearly labeled for easy installation. All 4" trough pegboards also come with a stabilizer bracket that attaches to the wall at the bottom of the pegboard and slips over the drain spout; keeping the pegboard secure against the wall.



Finished Back

In today's ever evolving lab environments wall space is not always available. Islands have become a mainstream design character in labs and can make installing pegboards slightly more challenging. However, by adding a finished back panel to your pegboard it will easily install to any utility chase, or reagent shelf system.

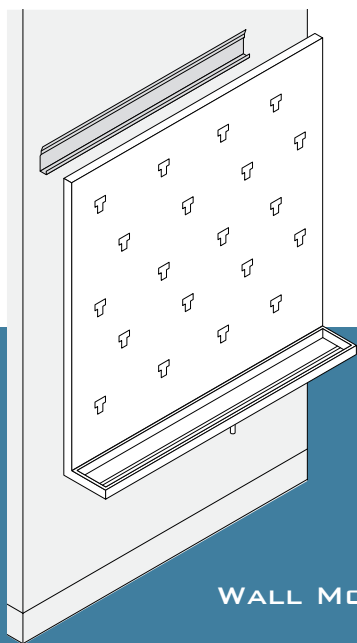

WALL MOUNT

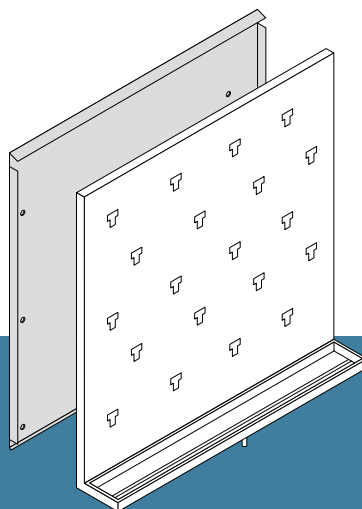

FINISHED BACK



Free Standing Assembly Brackets

If space becomes limited any Mod-Rack can be installed to a laboratory work surface. By simply adding our FSA brackets that are 23" tall x 7.5" at the base, the unit now becomes free standing. They are supplied with all the necessary hardware for attaching to a counter. Just add a finished back panel to the pegboard for support and soon your countertop becomes a workstation.

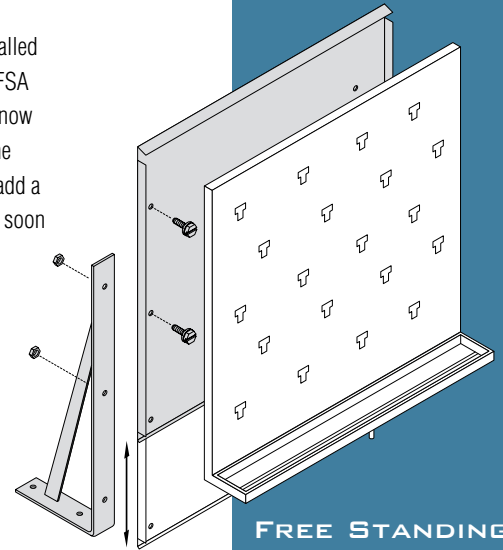

FREE STANDING ASSEMBLY



Raised Top Assembly

If wall, utility chase or countertop space is limited. Our raised top assembly allows you to lift the unit off the work surface as far as 12". Space below the pegboard is free and, if desired, two pegboards can be mounted back to back – maximizing your lab space to the fullest. Just add a finished back panel to the pegboard for support and soon your countertop becomes a workstation.

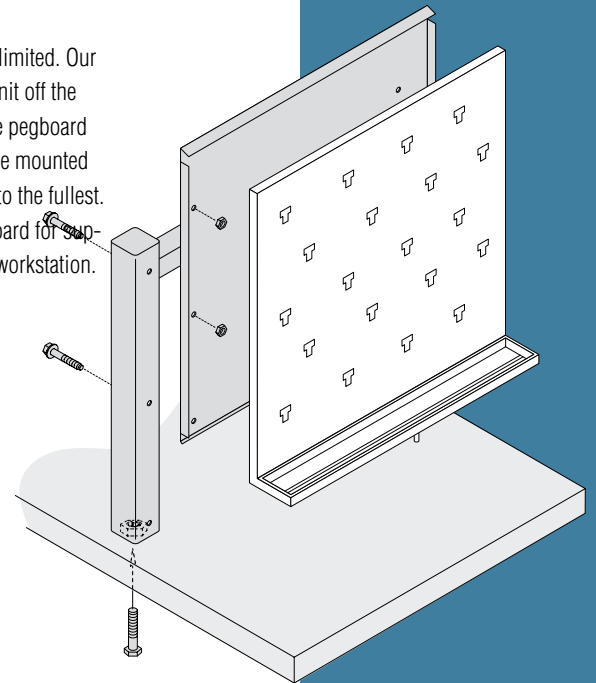

RAISED TOP ASSEMBLY

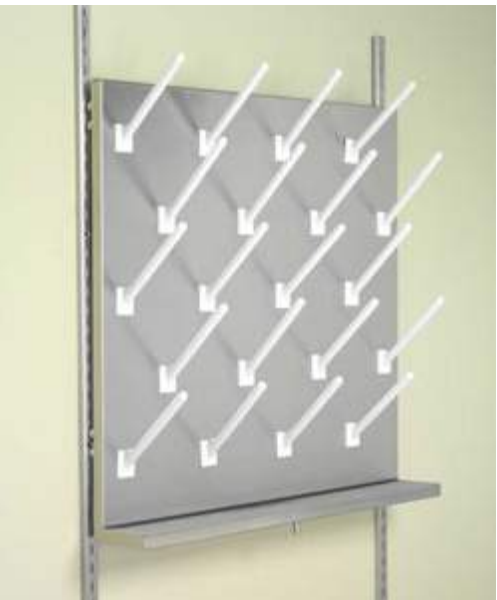

Wall Standard Mount

Mod-Racks can be mounted so they are fully adjustable, allowing you to raise or lower the unit to your desired height. The addition of an integral clip system to the back of the pegboard makes adjustment simple and any workstation that much more versatile. Just lift and clip it to the wall and now your pegboard is positioned at the height best for you. When ordering please add the suffix "AHB" to the pegboard product number and remember to order standards also.

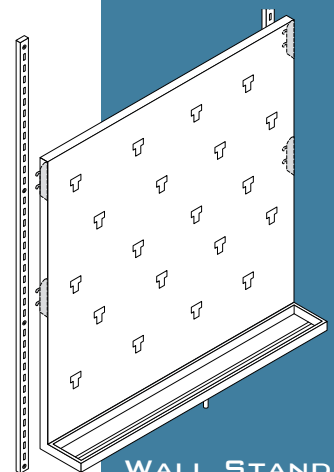

WALL STANDARD MOUNT

ACRYLIC PEGBOARDS

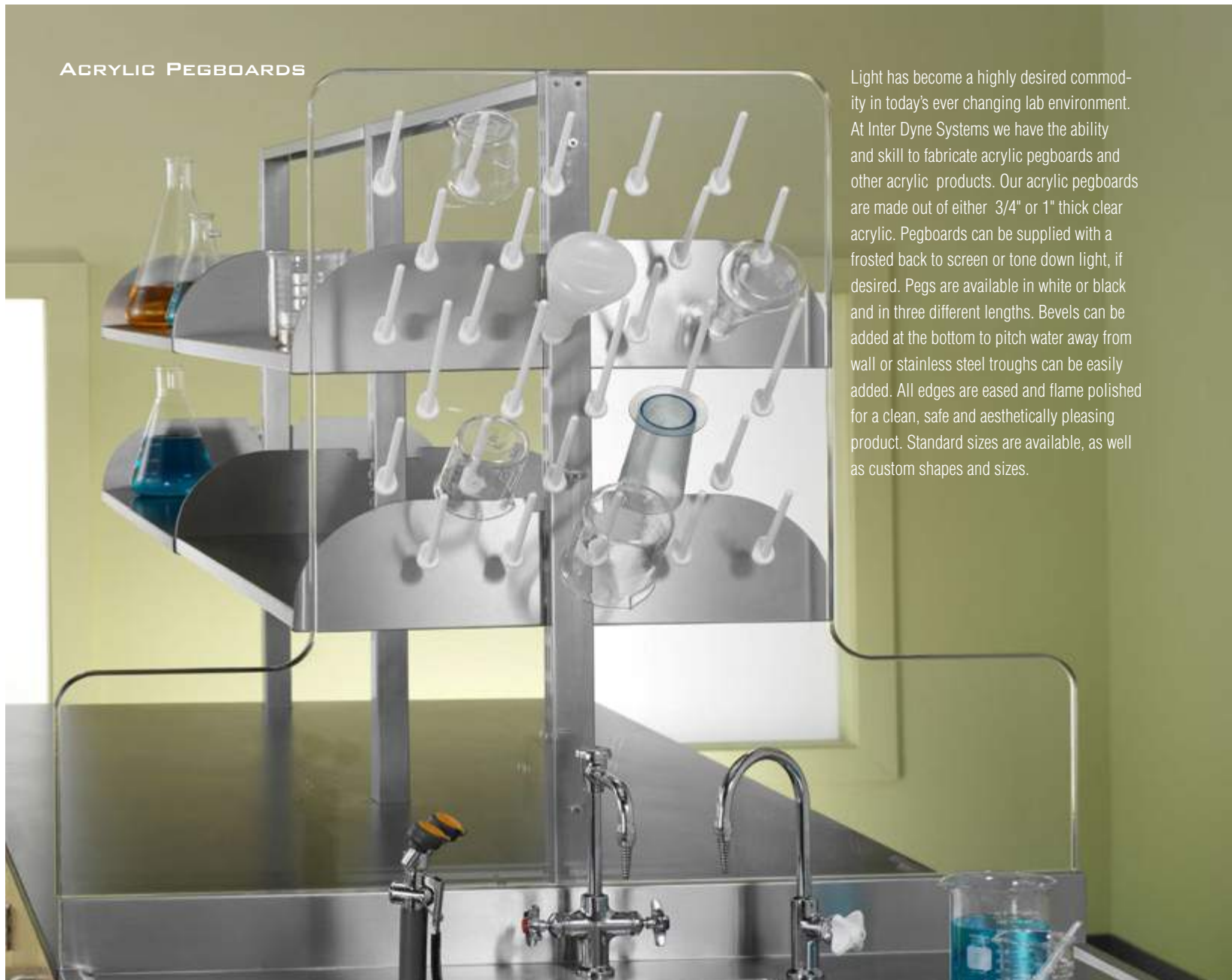

Light has become a highly desired commodity in today's ever changing lab environment. At Inter Dyne Systems we have the ability and skill to fabricate acrylic pegboards and other acrylic products. Our acrylic pegboards are made out of either 3/4" or 1" thick clear acrylic. Pegboards can be supplied with a frosted back to screen or tone down light, if desired. Pegs are available in white or black and in three different lengths. Bevels can be added at the bottom to pitch water away from wall or stainless steel troughs can be easily added. All edges are eased and flame polished for a clean, safe and aesthetically pleasing product. Standard sizes are available, as well as custom shapes and sizes.

EPOXY PEGBOARDS

At Inter Dyne Systems we understand how time can be of the essence for many lab dealers or end users. With this issue in mind we stock various standard sized epoxy pegboards that can be shipped quickly for immediate resolve. A stainless steel drip trough can be easily mounted to the bottom edge. Epoxy pegboards are black 1" thick and available with white or black pegs in a variety of lengths.



DRIP TROUGHS AND ACCESSORY OPTIONS

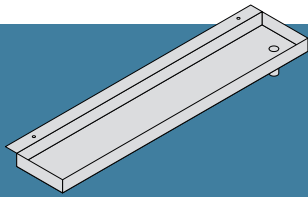

PEGBOARD MOUNT

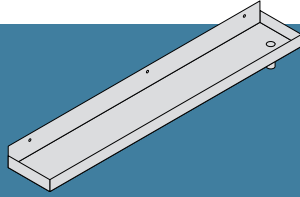

FACE MOUNT

Stainless steel drip troughs can be mounted to the bottom of any acrylic or epoxy pegboard. All troughs come with three feet of clear PVC tubing and pre-drilled holes for easy installation. You can select a stainless steel screen insert or drain grid to create an additional shelf-like surface for drying. All sizes are stocked and ready for immediate shipping.

Stainless steel face-mount drip troughs are designed for use with any pegboard. Troughs come complete with three feet of clear PVC tubing and pre-drilled holes for easy installation. Face-mount drip troughs can be ordered with a screen insert or drain grid to add additional drying or storage space. They are manufactured from high-quality stainless steel and are stocked for immediate shipment.

PEGBOARD MOUNT



FACE MOUNT



PEGBOARD MOUNT	FACE MOUNT	SCREEN INSERT	DRAIN GRID
HDT-18-2	FDT-18-2	SI-18-2	DG-18-2
HDT-18-4	FDT-18-4	SI-18-4	DG-18-4
HDT-20-2	FDT-20-2	SI-20-2	DG-20-2
HDT-20-4	FDT-20-4	SI-20-4	DG-20-4
HDT-24-2	FDT-24-2	SI-24-2	DG-24-2
HDT-24-4	FDT-24-4	SI-24-4	DG-24-4
HDT-30-2	FDT-30-2	SI-30-2	DG-30-2
HDT-30-4	FDT-30-4	SI-30-4	DG-30-4
HDT-32-2	FDT-32-2	SI-32-2	DG-32-2
HDT-32-4	FDT-32-4	SI-32-4	DG-32-4
HDT-36-2	FDT-36-2	SI-36-2	DG-36-2
HDT-36-4	FDT-36-4	SI-36-4	DG-36-4
HDT-42-2	FDT-42-2	SI-42-2	DG-42-2
HDT-42-4	FDT-42-4	SI-42-4	DG-42-4
HDT-48-2	FDT-48-2	SI-48-2	DG-48-2
HDT-48-4	FDT-48-4	SI-48-4	DG-48-4

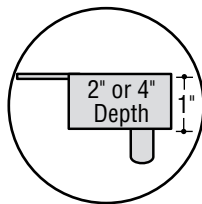

End View

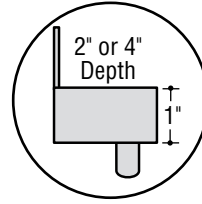

End View

STAINLESS STEEL SCREEN INSERTS & DRAIN GRIDS



SCREEN INSERT



DRAIN GRID

The stainless steel screen inserts & drain grids are ideal for keeping items off the bottom of the trough. Also they can be utilized as a drying shelf. These items can be used with any Inter Dyne Systems drip trough or Victoria Style pegboard. 4" wide screen insert and drain grid shown at left.

PEGBOARDS & ACCESSORIES

Inter Dyne Systems is the solution for outfitting your laboratory. Our pegboards, shelves, countertops, narcotic cabinets and specimen pass-through boxes are made of high-quality stainless steel to ensure a sterile and versatile workstation.

Our Mod-Rack™ pegboards come in a variety of sizes and mounting options and can be easily modified with our wide-selection of accessory options to meet the specific needs of your facility.

Contact a member of our friendly sales staff today to begin building your customized workstation.

“V” VICTORIA PEGBOARDS

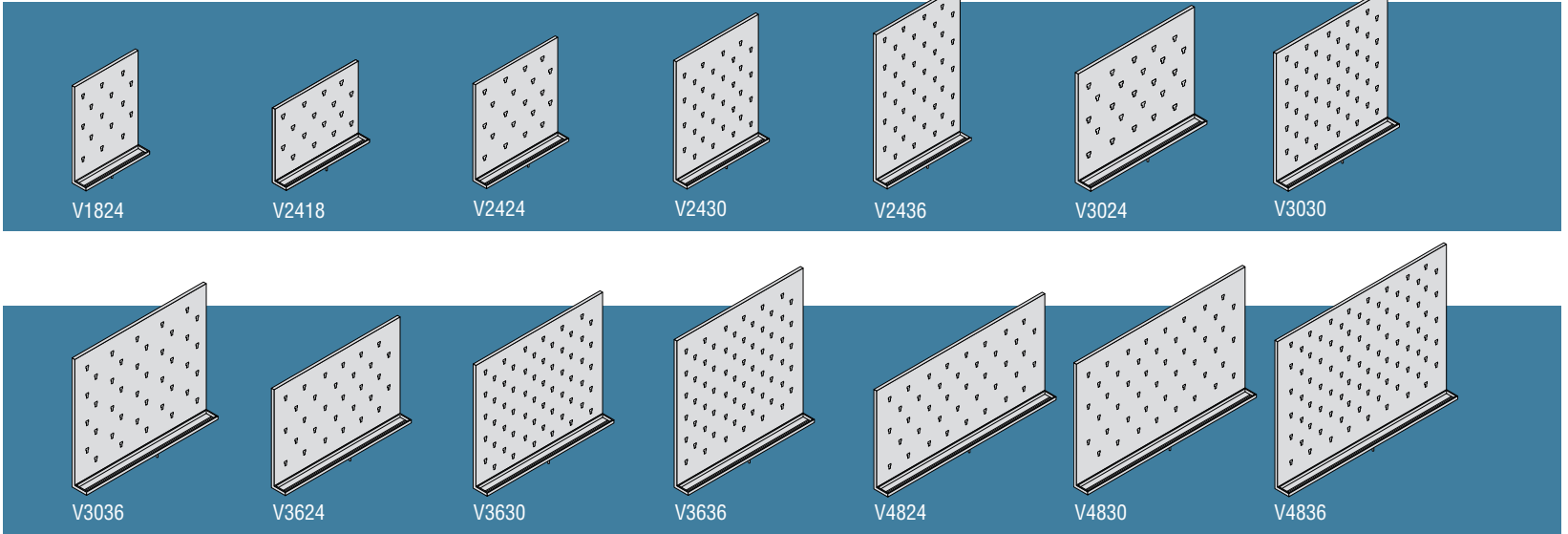

“B” BARON PEGBOARDS

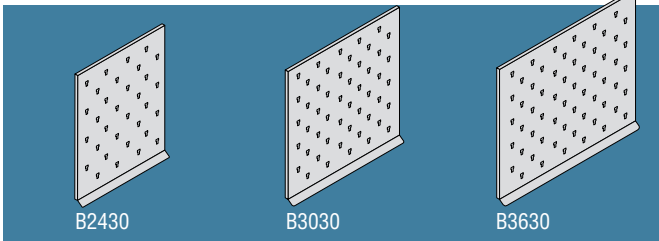

ACCESSORIES

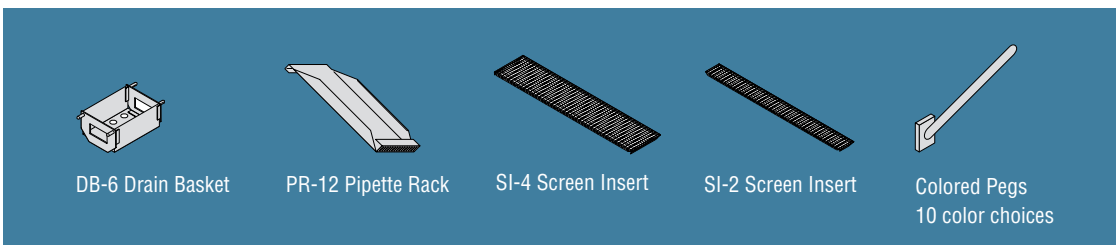
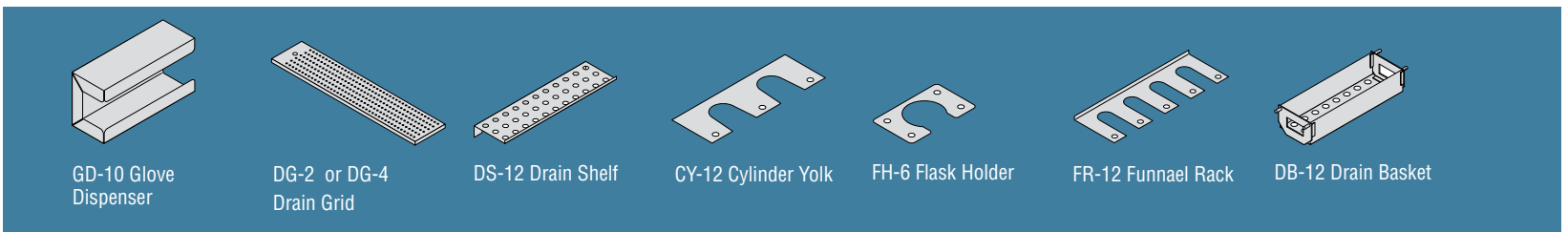
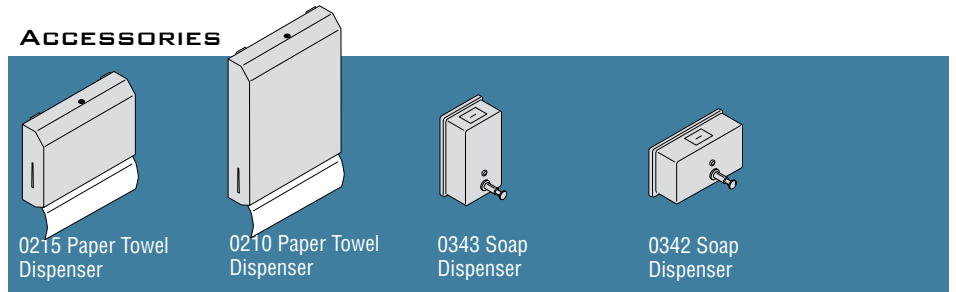

These products are covered by one or more of the following patents:
4,485,929; 3,912,212; 3,770,392; 5,163,567; 5,884,784



Inter Dyne Systems, Inc.
676 E. Ellis Road
Norton Shores, MI 49441

P: 877.477.5227 F: 231.799.9690
E: jack@interdynesystems.com
W: www.interdynesystems.com