

AFA 500

FUME HOOD ALARMS

Operating and Instruction Manual

1/9/03



Model AFA 500

- Built-in or Remote sensor
- 2 Relay inputs
- 1 Relay output
- Com port

Used for alarm indication and monitoring on Fume Hoods

OPERATOR DISPLAY PANEL



Built-in AIRFLOW SENSOR
Not visible when Remote AIRFLOW SENSOR is used

LED indicators

Function buttons Calibration.
ENTER – also used as Mute button for audible alarm

Connection details :-

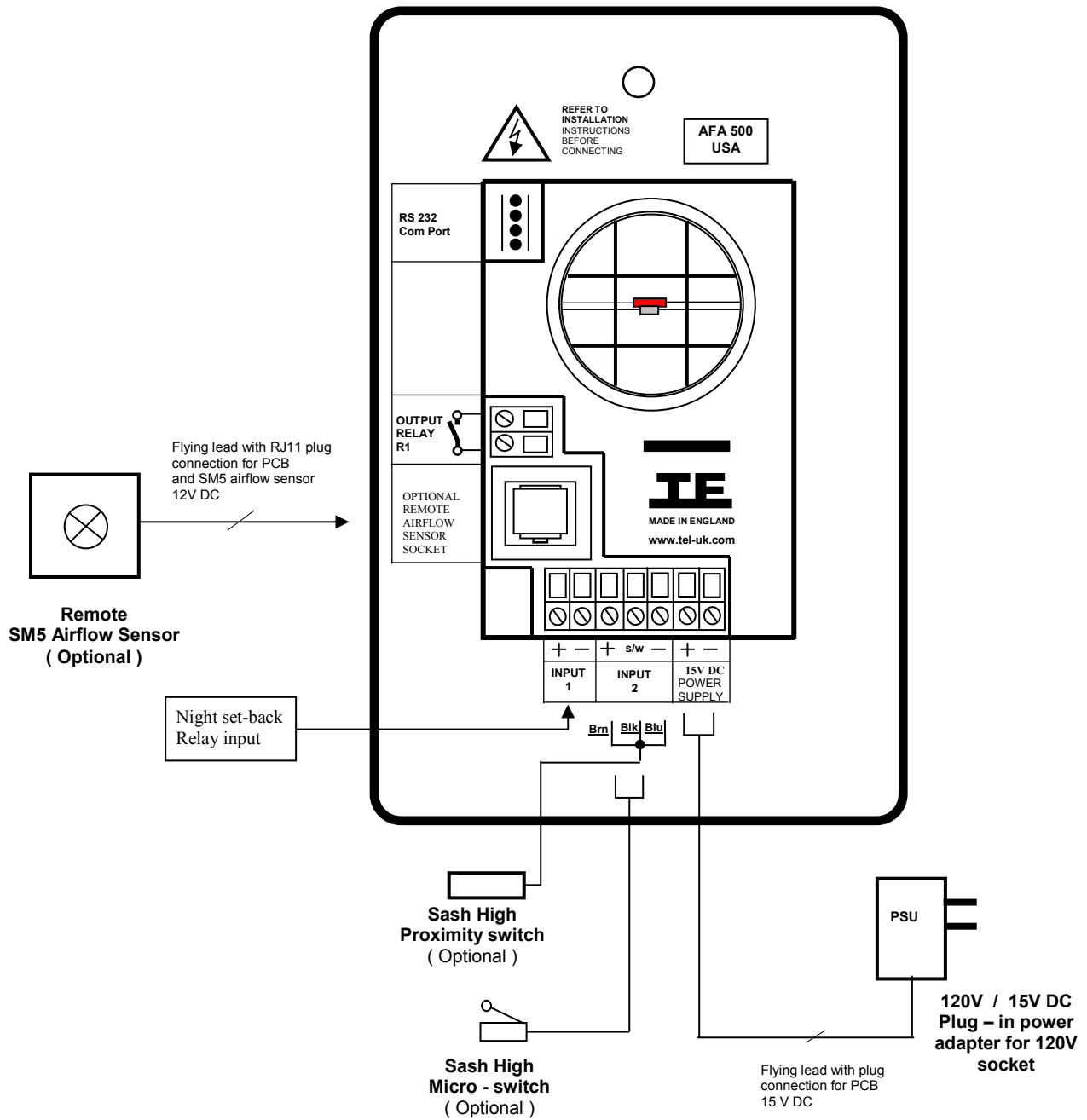

Notes:-

1. The socket for the remote SM5 Airflow Sensor is not provided as standard but is available on request. The unit operates with the in-built sensor **OR** the remote sensor.
2. The Sash High alarm can operate with the Micro switch **OR** the Proximity Switch. Both connection points are available as standard.

1.1 General Description

All systems comprise of the following components :-

1 – AFA 500 Alarm unit,
1 – AC power supply

If the Sash Alarm System option is ordered there will also be a sash micro switch or proximity switch.

If the Remote Airflow Sensor is ordered there will be remote sensor provided

Operator Features --- the alarm has the following operator features :-

Safe LED - Green LED (Not flashing) will be displayed if the airflow is greater than the Low air alarm point.

Alarm LED - Red LED (Not flashing) will be displayed if the airflow is lower than the Low air alarm point.

Sash High - Red LED (Flashing) will be displayed when the Sash is raised above the max safe working opening.

Audible Alarm -- the Audible alarm will sound (can be muted) in the Air Fail and the Sash High alarm condition

Night Set-back -- when the Night Setback input is activated the Audible alarm will be muted and the **Green LED will flash on/off**

ENTER --- the alarm has an Enter button -- this is multi-functional as follows :-

Press **Enter** momentarily when Low Air alarm is sounding will mute the alarm

Press **Enter** momentarily when Sash High alarm is sounding will mute the alarm and initiate a repeat timer that will re-sound the alarm if the Sash is not lowered to a safe position before the end of the time period

Press **Enter** for 5 secs will gain access to **Calibration** mode

SET -- used during the airflow Calibration of the alarm

External Connections -- the alarm unit will have the following connection points :-

Input 1 --- volt free relay input – (close contact to activate the input)

This input is configured as :-

NIGHT SETBACK

Output R1 --- volt free relay output - (contact closes on activation)

This input is configured as :-

LOW AIR ALARM

Sash High Input --- a. Connection point for Sash High **micro switch**. (Switch contact to close and remain closed in Sash High condition)

b. Connection point for Sash High **proximity switch**. (Switch contact to close and remain closed in Sash High condition)

Note:- Use input a. OR input b. for the Sash High alarm

Remote Airflow Sensor -- Plug in connection for airflow sensor

Note:- The remote Airflow Sensor socket will only be available for units ordered without the built-in Airflow Sensor

Com Port --- to enable connection to Laptop or PC for full diagnostics , logging or setting up and for communications to building computer system (BMS)

Power supply --- low voltage DC power supply 15V DC

1.2 Alarm Configuration / Calibration

The alarm is supplied with a factory configuration.

The only part of the configuration that can be changed is the setting for the Sash High repeat timer time delay -- if required this can be changed by connection to a Laptop or PC via the RS232 com port.

The alarm has **two modes for the calibration of the airflow alarm point**. These two modes are selectable via a 'jumper connection' on the back of the alarm PCB. The jumper is labelled as **CAL** and is situated on the edge of the PCB above the Com port.

The two calibration modes are :-

a. With the Jumper connected - The airflow is reduced to the alarm point mechanically and this airflow is 'captured' by the alarm. The airflow is then restored to the normal operating value and the Low Air alarm will activate if the airflow subsequently falls to the alarm point

b. With the Jumper not connected - This is a two point calibration method. The airflow is set to the normal operating value and this value is 'captured' by the alarm and taken to be 100%. The airflow is then increased to one and a half times the normal operating value and this value is 'captured' by the alarm and taken to be 150%. The Low Air alarm will then activate if the airflow subsequently falls to 80% of the normal operating value.

See 'Quick Start Installation' below for details of the Calibration procedures

1.3 Start up

When unit is powered up the following sequence of events occur :-

1. The 12V DC power is applied to the airflow sensor and the alarm then performs a self test on the functions, LEDs and audible alarm (approx 2 sec) and then initiates a delay timer of 30 secs to allow the airflow sensor to stabilise.
2. During the whole of the 30 sec period all alarms and relay outputs are inhibited and the Red & Green LEDs will be permanently ON.
3. At the end of the 30 sec delay the unit performs one of two options :-
 - a. If the alarm calibration has been previously completed -- the unit goes to normal operating mode (Run)
 - b. If the unit has not been calibrated -- the Red & Green LEDs will flash on/off and the audible alarm will be muted. It is then possible to press the Enter button for 5 secs and go into the calibration mode -- (See 'Quick Start Installation' below for details of the Calibration procedures)

1.4 Events / actions

Safe airflow

- Airflow above alarm level (eg > 80 fpm)
- Green LED on

Low airflow

- Airflow below alarm level for longer than the low air delay time (5 secs)
- Red LED on (Not flashing)
- Audible alarm sounds ('Beep' on/off every 1 sec) -- can be muted via Enter pushbutton
- Low air relay R1 operates.

Reset : -- when airflow rises above Low air level for longer than the low air to safe air delay time (2 secs) the Low air alarm resets automatically

Sash High

- When the input configured as Sash High is activated (Micro switch or Proximity switch)
- Red LED on (Flashing)
- Audible alarm sounds ('Beep' on/off every 1 sec)
- Audible can be muted via Enter pushbutton -- this silences the alarm and initiates a repeat timer (factory set to 5 mins) After the delay time the alarm re-sounds (and can be re-muted). During this time the Red LED flashes on / off.

Reset: -- when Sash lowered to safe position and input de-activated.

Night set-back

- When input configured as Night set-back is activated
- Green LED on (Flashing)
- Audible alarm muted

Airflow Sensor Error

- The connection and each element of the airflow sensor are monitored at all times. In the event of a problem with the sensor the audible alarm will sound using a different and distinctive tone best described as ' a modulating siren effect'
- The audible alarm can only be silenced by re-connecting the sensor (if a remote sensor is being used) or switching the power to the unit off.

2.1 Quick Start Installation

Follow the instructions below for installing and commissioning the unit. :-

Before connecting the unit it is important to decide on the type of calibration that is to be used on the installation. The two methods are described in section 1.2 Alarm Configuration / Calibration above.

1. Fit the alarm to the Fume Hood using the cut-out details provided with the unit --- see page 11
2. If using a remote airflow sensor fit to the Fume Hood using the cut out and installation details provided --- see page 12 & 13 and connect the 'telephone style' airflow sensor plug-in cable to the sensor and the back of the alarm unit --- see typical connection diagram on page 14 & 15
3. Plug in the power adapter to a Mains AC power socket and connect the flying lead to the alarm unit --- see typical connection diagram on page 14 & 15
4. Power up the unit and wait at least 30 secs while the sensor temperature stabilises. During this time the Red & Green LEDs will both be on (not flashing)
If the unit has not been previously calibrated the Red & Green LEDs will begin to flash on/off at the end of the 30 sec start up time delay but the audible alarm will not sound. If the alarm has been calibrated it will go into normal operation.
5. **Calibration :-**

Alarm Point Capture (With CAL jumper on PCB connected)

- a. Open the Sash to the normal operating height and adjust the face velocity to the Low Air alarm value using a calibrated instrument to check the value.
- b. Press and hold the Enter button for 5 secs to go into the Calibration mode. This is indicated by both Red and Green LEDS flashing on/off together will the audible alarm sounding ('Beep' on/off 4 times every 1 sec).
- c. To initiate the alarm point calibration press and hold the ENTER and the SET button at the same time. The unit will then sample the airflow for a 5 sec period during which time the Green LED goes off and the Red LED flashes on/off. The audible alarm continues to sound during this period and if the sampling is successful will give a two tone beep at the end of the period and the unit will then go automatically into the Run mode.
If the buttons are released during the sampling period or if the airflow is fluctuating more than the pre-set value the audible alarm will give a lower frequency buzzing sound for a short period and then go back into the calibration mode. If this occurs re-press the ENTER and SET buttons to repeat the airflow sampling.
- d. When complete re-set the airflow to the normal value and the unit will go to the Safe running condition with the Green LED on.

The unit will now function and go into the ALARM condition if the Fume Hood face velocity falls below the alarm value.

Calibration continued:-

Two Point Capture (With CAL jumper on PCB not connected)

- a. Open the Sash to the normal operating height and adjust the face velocity to the normal operating value using a calibrated instrument to check the value.
- b. Press and hold the Enter button for 5 secs to go into the Calibration mode. This is indicated by both Red and Green LEDs flashing on/off together with the audible alarm sounding ('Beep' on/off 4 times every 1 sec).
- c. To initiate the normal airflow (100%) calibration press and hold the ENTER and the SET button at the same time. The unit will then sample the normal airflow for a 5 sec period during which time the Green LED goes off and the Red LED flashes on/off. The audible alarm continues to sound during this period and if the sampling is successful will give a two tone beep at the end of the period and the unit will then go automatically into the higher airflow calibration mode.
If the buttons are released during the sampling period or if the airflow is fluctuating more than the pre-set value the audible alarm will give a lower frequency buzzing sound for a short period and then go back into the calibration mode. If this occurs re-press the ENTER and SET buttons to repeat the airflow sampling.
- d. The higher airflow calibration mode is indicated by both Red and Green LEDs flashing on/off together with the audible alarm sounding ('Beep' on/off for 2 secs every 10 secs).
Close the Sash down until the face velocity rises to one and a half times the normal operating value used in a. above using a calibrated instrument to check the value
To initiate the higher airflow (150%) calibration press and hold the ENTER and the SET button at the same time. The unit will then sample the higher airflow for a 5 sec period during which time the Green LED goes off and the Red LED flashes on/off. The audible alarm continues to sound during this period and if the sampling is successful will give a two tone beep at the end of the period and the unit will then go automatically into the Run mode.
If the buttons are released during the sampling period or if the airflow is fluctuating more than the pre-set value the audible alarm will give a lower frequency buzzing sound for a short period and then go back into the calibration mode. If this occurs re-press the ENTER and SET buttons to repeat the airflow sampling.

The unit will now function and go into the ALARM condition if the Fume Hood face velocity falls below 80% of the normal operating value.

2.2 Calibration Notes :-

1. The two calibration methods are intended to give the installer two options for calibrating the alarm.
2. Using the Alarm Point Capture method it is necessary to adjust the face velocity on the fume hood using a mechanical damper (or fan speed control if available) to the desired alarm point and this is sampled by the unit. It is then necessary to re-adjust the face velocity back to the normal operating value. This method produces a very accurate alarm point at a fixed value but involves getting access to the ductwork or fan speed controller

3. The second method of Two Point Capture is slightly more involved but does not require any access to the ductwork or fan speed controller and is generally a quicker solution.

The principle behind this method is as follows :-

The output from the airflow sensor is linear over the normal operating range of the face velocities on fume hoods. If we therefore capture the airflow sensor output at two known points we can then calculate the alarm point and give an alarm when the airflow falls below this value. However because the AFA 500 does not have a digital display of the face velocity we can not enter particular values into the alarm. For this reason we take the normal operating value of the face velocity with the sash open to the max safe working opening and call this 100% -- this point is captured during the first sample. Then by closing the sash it is possible to create a face velocity which is one and a half times the normal operating value ie 150% -- this point is captured during the second sample. We then use these two values to calculate the sensor output at 80% and this becomes the Low Air alarm point.

The actual value of the normal operating face velocity is not important and in each case the alarm point will be 80% of this value.

For example:-

A normal face velocity of 100 fpm would give an alarm point of 80fpm

A normal face velocity of 80 fpm would give an alarm point of 64 fpm

4. The face velocity readings on the open sash may vary at different points on the measuring grid by up to 20 fpm. This is quite acceptable in terms of the fume cupboard performance so long as no individual point is below the designated Low Air alarm point .The figure entered for the calibration point can be taken as the average value of all the measuring grid readings or could be taken as the individual lowest point on the grid. For most fume hoods this low point is on the bottom row in the centre and is a convenient position to measure and for future reference when checking the alarm during annual maintenance.
5. Take time when measuring the face velocities for the calibration procedure to allow for the velocities across the open sash to stabilise. If the velocities are changing or are turbulent during the sampling period the alarm will detect this and give a low frequency buzz at the end of the sample indicating that the sample must be repeated.

3.0 Dimensions

Alarm Panel Dimensions

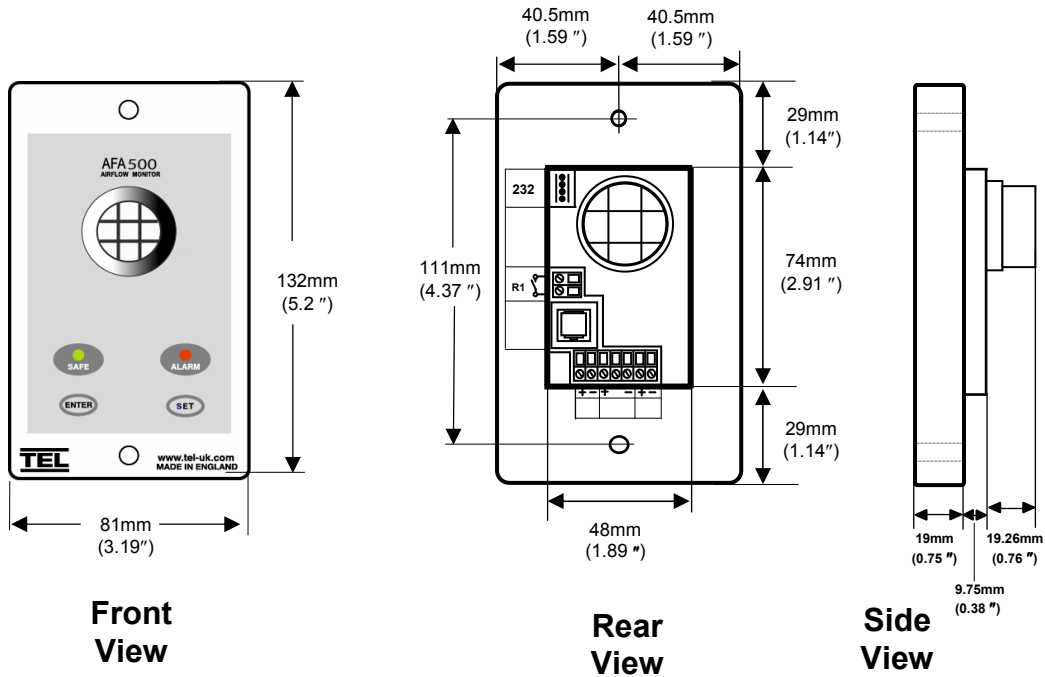

Panel Cutout Dimensions

3.00" x 2.00"

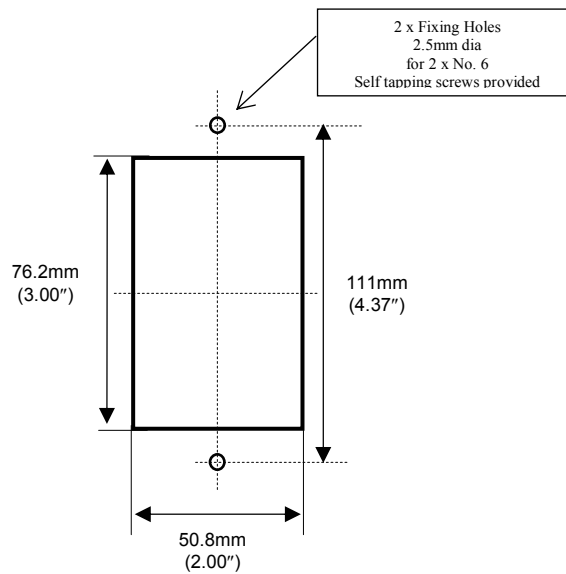

NOT TO SCALE

3.0 Dimensions

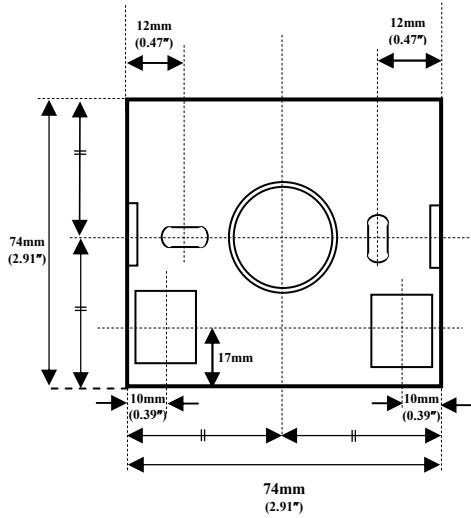

**SM5 Sensor
Dimensions
(Rear view)**

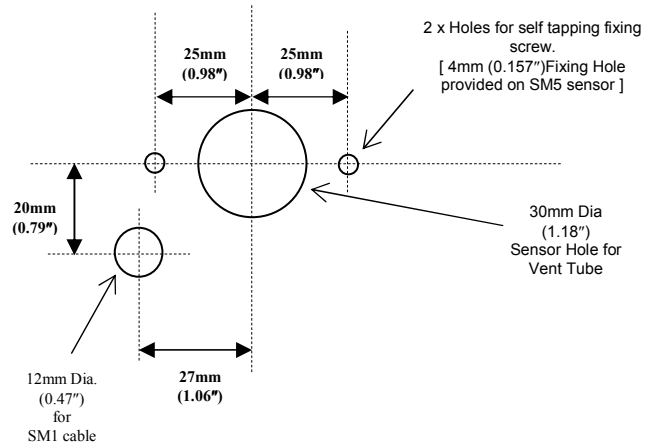

**SM5 Sensor
Panel Cutout
Dimensions
(Front view)**

NOTE: The optional Remote sensor and connecting socket on the AFA 500 are not included as standard

4.0 SM5 Airflow Sensor Installation

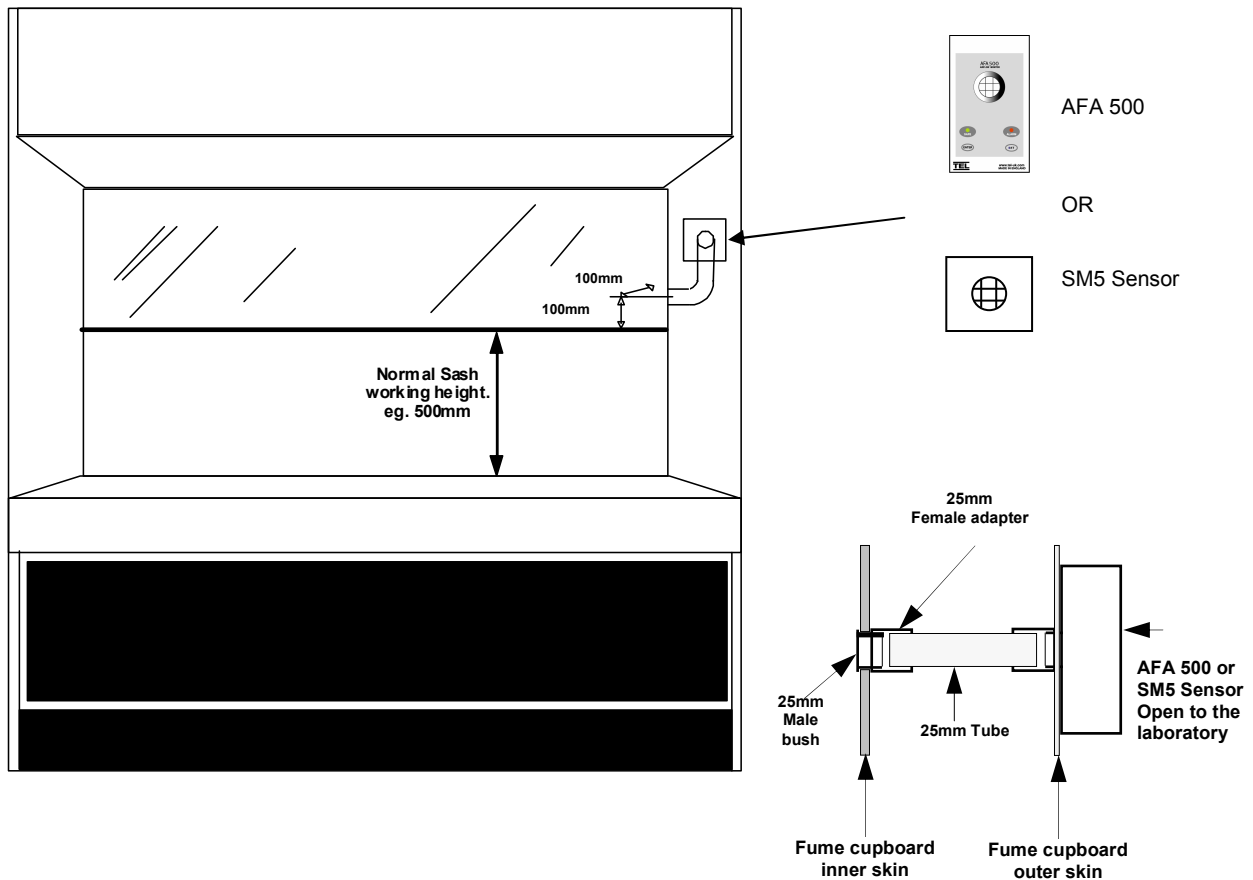

It is very important to position the AFA 500 or SM5 airflow sensor in the correct position to give long term stable reading of the face velocity. Please read the INSTALLATION NOTES below and if in doubt contact us for further advice.

INSTALLATION NOTES :-

1. The AFA 500 or SM5 sensor must be positioned where it can " see " the room pressure of the laboratory. The back connection spigot of the sensor is designed to accept a 25mm OD tube which should be connected to the inner chamber of the fume hood. (This tube and fittings is known as the " vent kit ")
The **ideal position** for the end of the 25mm tube for most fume hoods is 100mm back from the sash glass and 100mm higher than the normal sash opening height through the inner side wall.
2. If possible mount the sensor on the front of the fume hood and use a short length of tube. Tube lengths of more than 1metre or smaller diameter will restrict the airflow through the sensor. This will lead to too much sensitivity being required to calibrate the unit which can lead to some instability of the reading or incorrect readings at low velocities!
3. For fume hoods with a single skin side wall or a double skin with a small gap between them it may not be possible to achieve the ideal sensing position using a flexible tube.
With a single skin side wall it is possible to fix the sensor on the outside of the fume hood and connect directly to the inner chamber in the ideal position. This method can only be used for up to two fume hoods when they are positioned side by side (using the two outer walls).
An alternative method is to mount the sensor on the front of the fume hood and connect using a short flexible tube to a rigid wall tube attached to the inner side wall. The open end of this rigid wall tube should be positioned in the 'ideal position' ie. 100mm back from the sash and 100mm higher than the normal sash opening.
Fume hoods with a high internal height can present a difficulty because the tube length to reach the ideal position may be longer than 1 metre. In this case it is better to use a tube no longer than 1 metre which may result in a sensing position higher than the ideal.
When fitting a sensor to a 'narrow wall' fume hood for the first time it may be necessary to try various combinations of rigid and flexible tube to find the best combination and position.
4. The sensor should not be mounted in a position where it is subject to draughts from the laboratory air input or ventilation system.

5.0 Typical Wiring Diagram

Standard Alarm with built-in Airflow Sensor

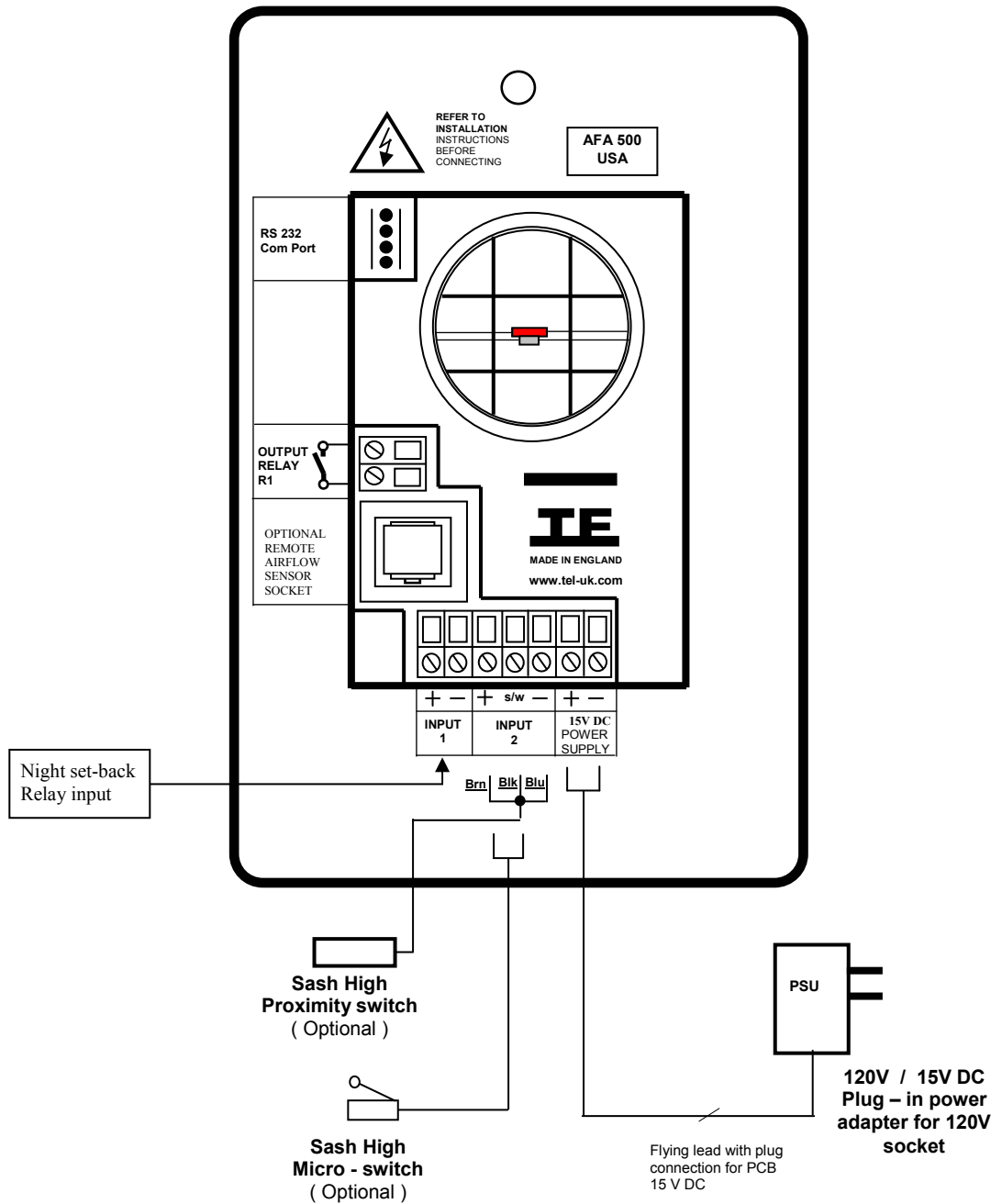

5.1 Typical Wiring Diagram

Alarm with REMOTE Airflow Sensor

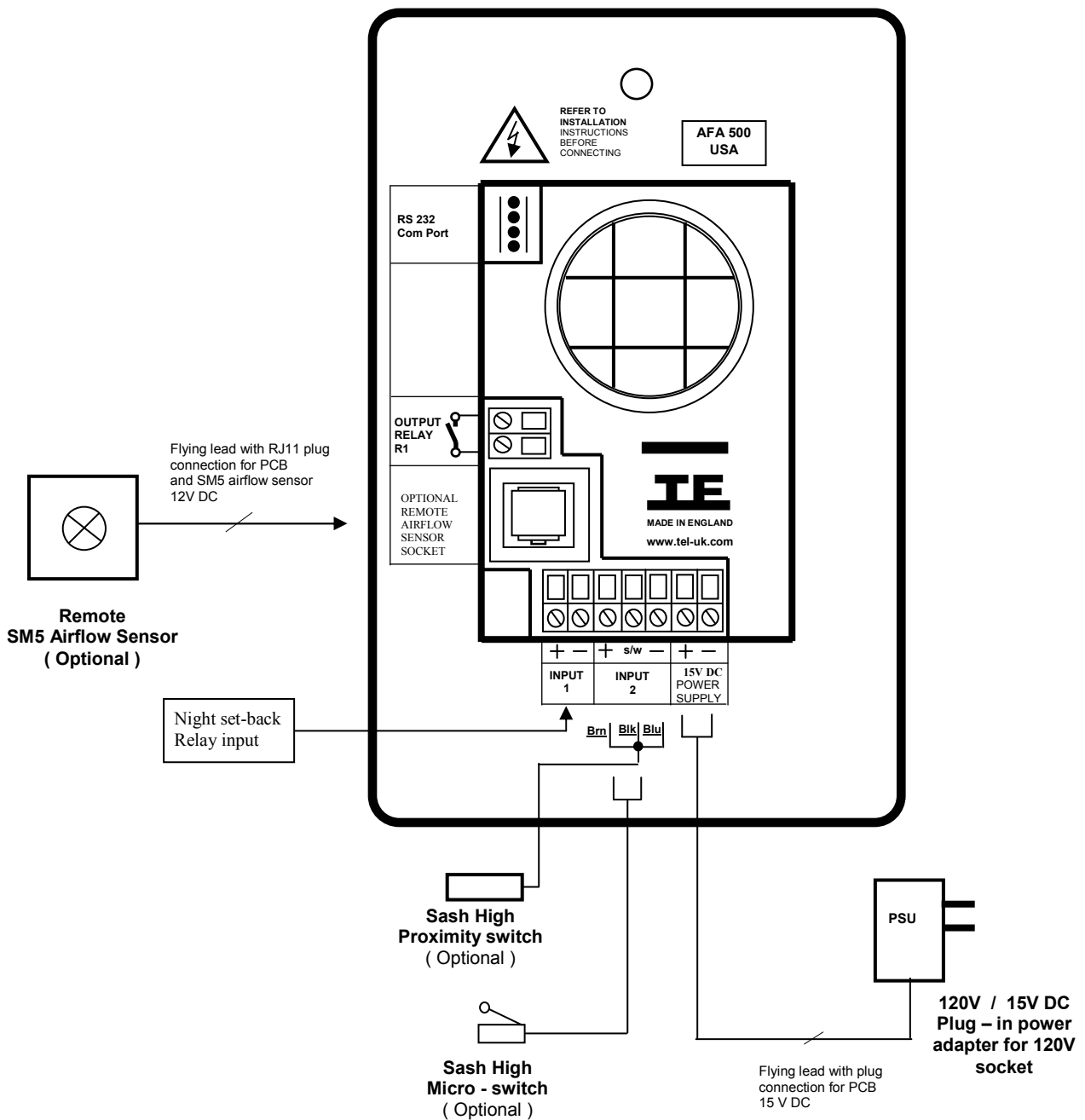

6.0 LIMITATION OF WARRANTY AND LIABILITY

Seller warrants that this product, under normal use and service as described in the operator's manual shall be free from defects in workmanship and material for a period of twelve (12) months, or the length of time specified in the operator's manual, from the date of shipment to the customer. This limited warranty is subject to the following exclusion :-

- a. Batteries and certain other components when indicated in specifications are warranted for a period of 90 days from the date of shipment to the customer.
- b. With respect to any repair services rendered, Seller warrants that the parts repaired or replaced will be free from defects in workmanship and material, under normal use, for a period of 90 days from the date of shipment to the customer
- c. Seller does not provide any warranty on finished goods manufactured by others. Only the original manufacturer's warranty applies.
- d. Unless specifically authorised in a separate writing by Seller, Seller makes no warranty with respect to, and shall have no liability in connection with, any goods which are incorporated into other products or equipment by the Buyer. All goods returned under warranty shall be at the Buyer's risk of loss, Seller's factory prepaid, and will be returned at Seller's risk of loss, Buyer's factory prepaid.

The foregoing is IN LIEU OF all other warranties and is subject to the conditions and LIMITATIONS stated herein. NO OTHER EXPRESS OR IMPLIED WARRANTY OF FITNESS FOR PARTICULAR PURPOSE OR MERCHANTABILITY IS MADE.

THE EXCLUSIVE REMEDY OF THE USER OR PURCHASER, AND THE LIMIT OF LIABILITY OF SELLER FOR ANY AND ALL LOSSES, INJURIES, OR DAMAGES IN CONNECTION WITH THIS PRODUCT (INCLUDING CLAIMS BASED ON CONTRACT NEGLIGENCE, STRICT LIABILITY, OTHER TORT, OR OTHERWISE) SHALL BE THE RETURN OF THE PRODUCT TO THE FACTORY OR DESIGNATED LOCATION AND THE REFUND OF THE PURCHASE PRICE, OR, AT THE OPTION OF THE SELLER, THE REPAIR OR REPLACEMENT OF THE PRODUCT. IN NO EVENT SHALL SELLER BE LIABLE FOR ANY SPECIAL, INCIDENTAL OR CONSEQUENTIAL DAMAGES. SELLER SHALL NOT BE RESPONSIBLE FOR INSTALLATION, DISMANTLING, REASSEMBLY OR REINSTALLATION COSTS OR CHARGES. NO ACTION, REGARDLESS OF FORM, MAY BE BROUGHT AGAINST THE SELLER MORE THAN ONE YEAR AFTER THE CAUSE OF ACTION HAS ACCRUED.

The purchaser and all users are deemed to have accepted the terms of this LIMITATION OF WARRANTY AND LIABILITY, which contains the complete and exclusive limited warranty of Seller. This LIMITATION OF WARRANTY AND LIABILITY may not be amended or modified nor may any of its terms be waived except by a writing signed by an authorised representative of the Seller.

7.0 Contact us :-

For further information on our range of airflow alarms and controls please contact us at :-



HOLLAND SAFETY EQUIPMENT

726 McKinley Ave.

Libertyville, Illinois 60048

Phone : 847- 680-9930 Fax : 847-680-9938

e-mail: info@hollandsafety.com

web site: www.hollandsafety.com



Temperature Electronics Ltd

Export sales :-

Tel : + 44 161 257 2541 Fax : + 44 161 228 8817

e-mail: xportsales@exportsales.com

web site: www.tel-uk.com